

Service
Service
Service

For description of the operation see F7113/00 part I

Service Manual

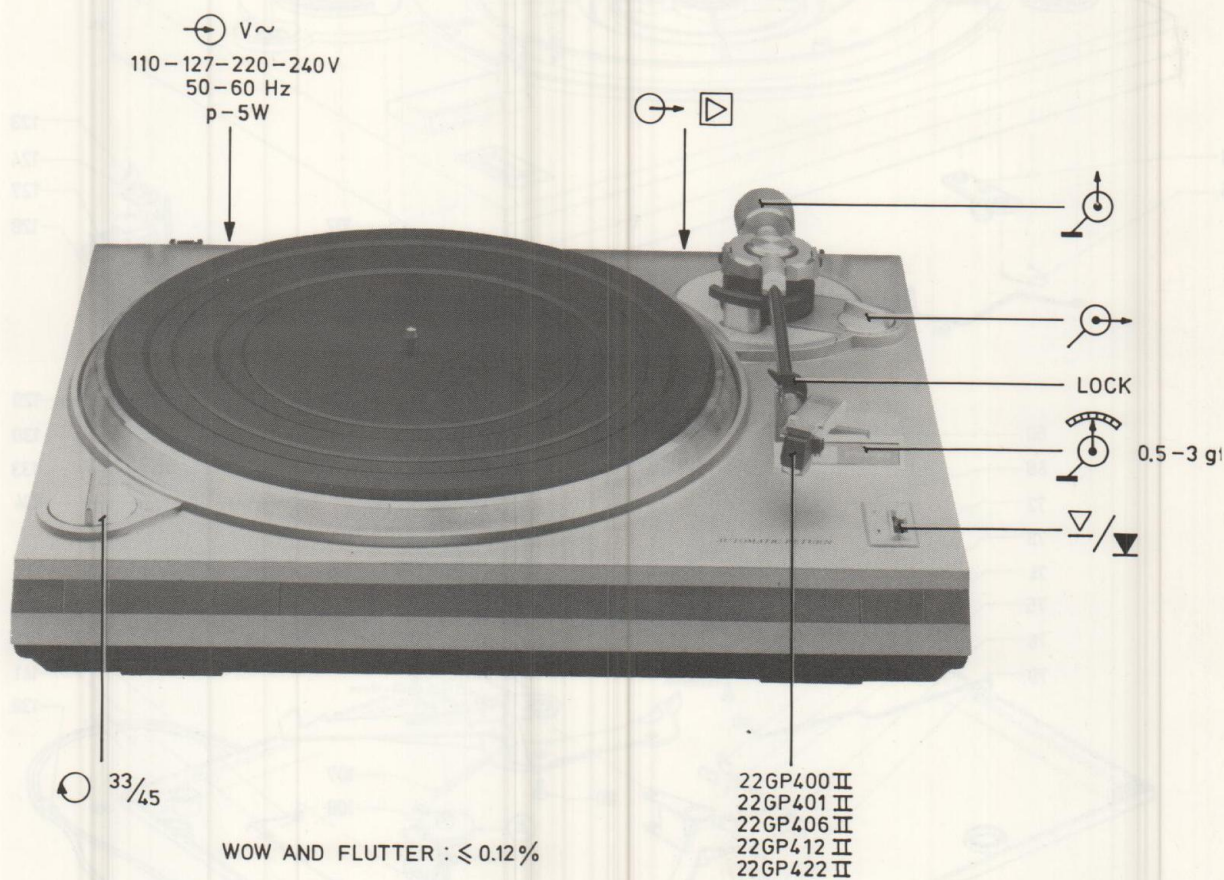

22 791 B12

Documentation Technique Service Dokumentation Documentazione di Servizio Huolto-Ohje Manual de Servicio Manual de Servicio



"Pour votre sécurité, ces documents doivent être utilisés par des spécialistes agréés, seuls habilités à réparer votre appareil en panne".

Subject to modification

4822 725 14588

Printed in The Netherlands

PHILIPS

CS 79 580

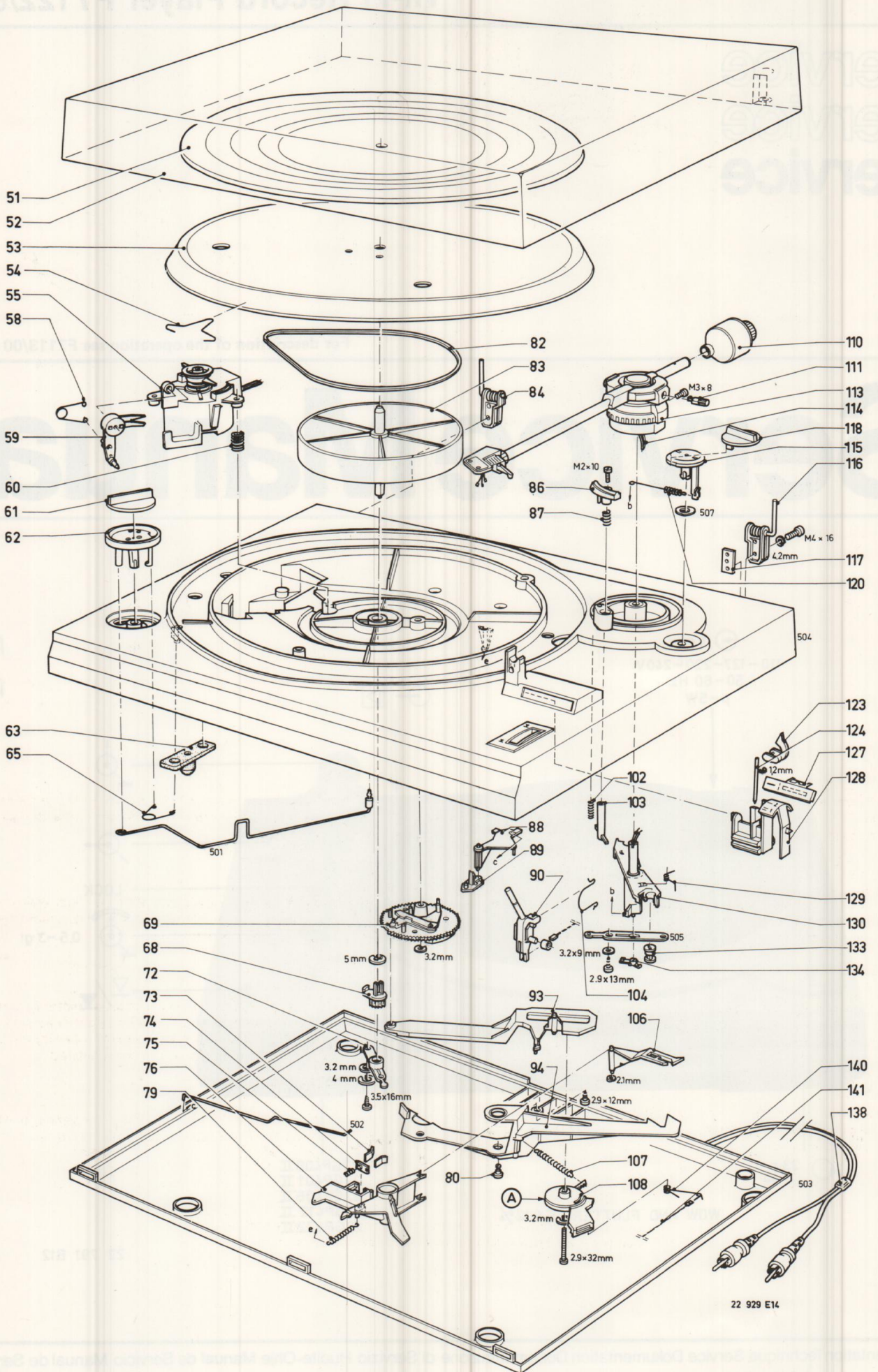

Fig. 1

51	4822 466 50133	80	4822 462 71061
52	4822 462 71192	82	4822 358 30279
53	4822 528 10405	83	4822 402 60735
54	4822 492 61215	84	4822 417 10674
55	4822 361 20187	86	4822 402 60736
58	4822 492 31654	87	4822 492 51321
59	4822 402 60726	88	4822 402 60729
60	4822 492 50845	89	4822 402 60633
61	4822 413 40959	90	4822 413 30899
62	4822 413 40958	93	4822 402 60731
63	4822 462 40407	94	4822 402 50179
65	4822 492 31882	102	4822 492 51319
68	4822 522 20161	103	4822 402 60728
69	4822 522 31312	104	4822 492 62278
72	4822 520 10442	106	4822 402 50158
73	4822 290 80389	107	4822 492 31657
74	4822 290 80388	108	4822 402 60828
75	4822 492 51318	110	4822 691 30106
76	4822 402 50157	111	4822 520 10441
79	4822 492 31234	113+111	4822 251 70197

114	4822 323 50054
115	4822 413 40961
116	4822 417 10673
117	4822 417 10544
118	4822 413 40962
120	4822 492 31655
123	4822 402 60727
124	4822 535 91165
127	4822 381 10519
128	4822 691 30088
129	4822 492 31661
130	4822 535 60052
133	4822 528 30234
134	4822 402 60686
138	4822 321 20384
140	4822 492 62279
141/00	4822 321 30221
141/30	4822 321 30235

Lubricating Instruction:

- (A) Silicon oil 100.000 CST 4822 390 80113 item 108

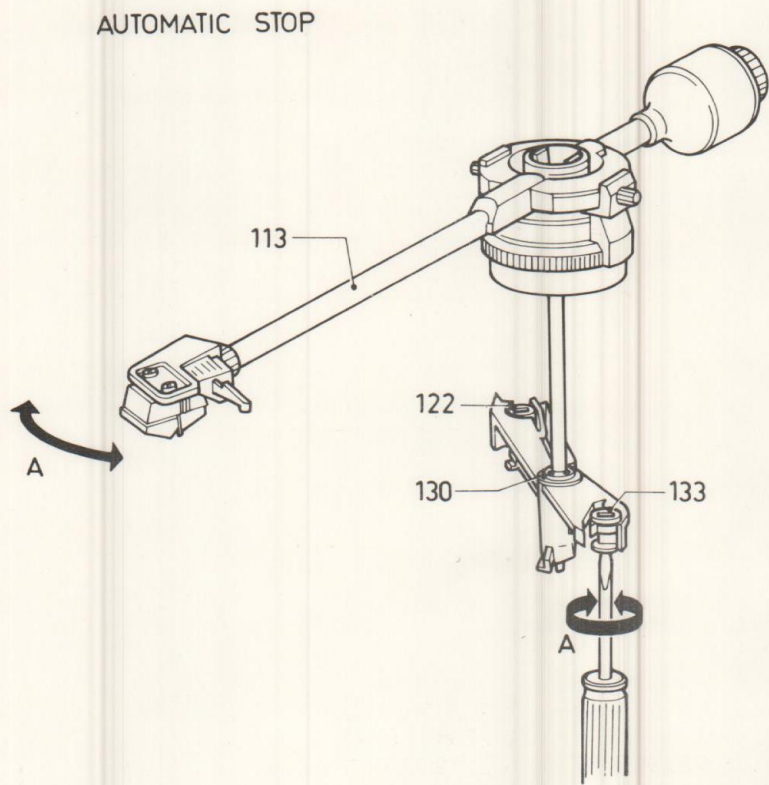
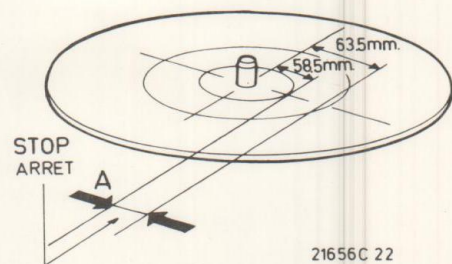

Fig. 2



21656C 22

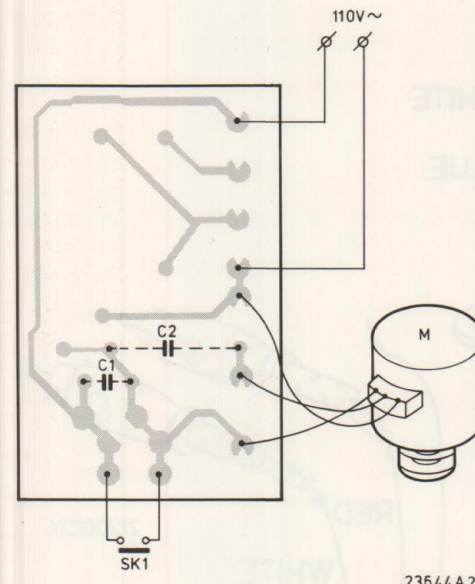

Fig. 3

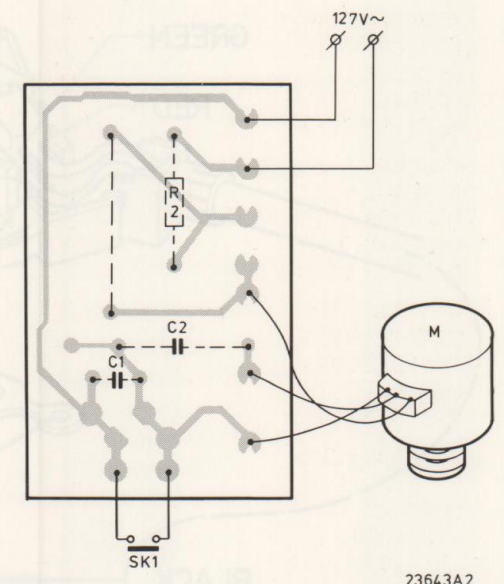

Fig. 4

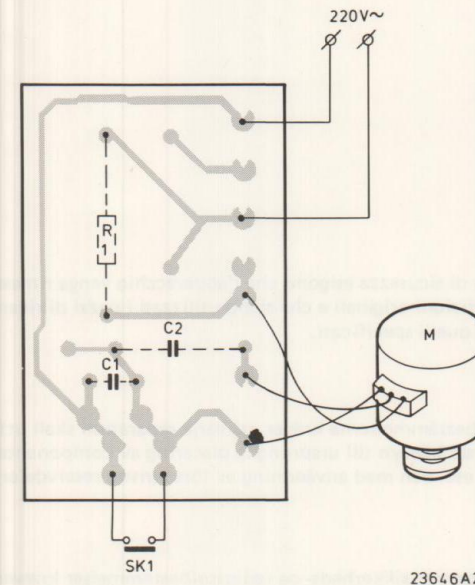

Fig. 5

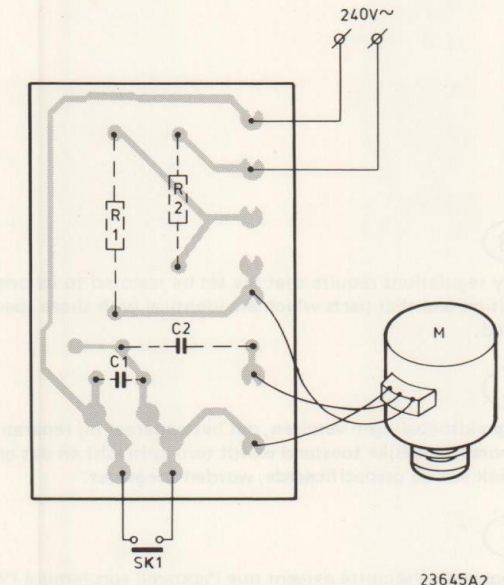

Fig. 6

R1	6.8 kΩ ± 5% 5.5 W	4822 112 41129
R2	1 kΩ ± 5% 0.5 W	4822 111 50143
C1	4700 pF ± 20% 400 V	4822 122 10113
C2 (50 Hz)	0.82 μF ± 10% 400 V	4822 121 40446
C2 (60 Hz)	0.68 μF ± 10% 400 V	4822 121 40444
M (50 Hz)		4822 361 20187
M (60 Hz)		4822 361 20225

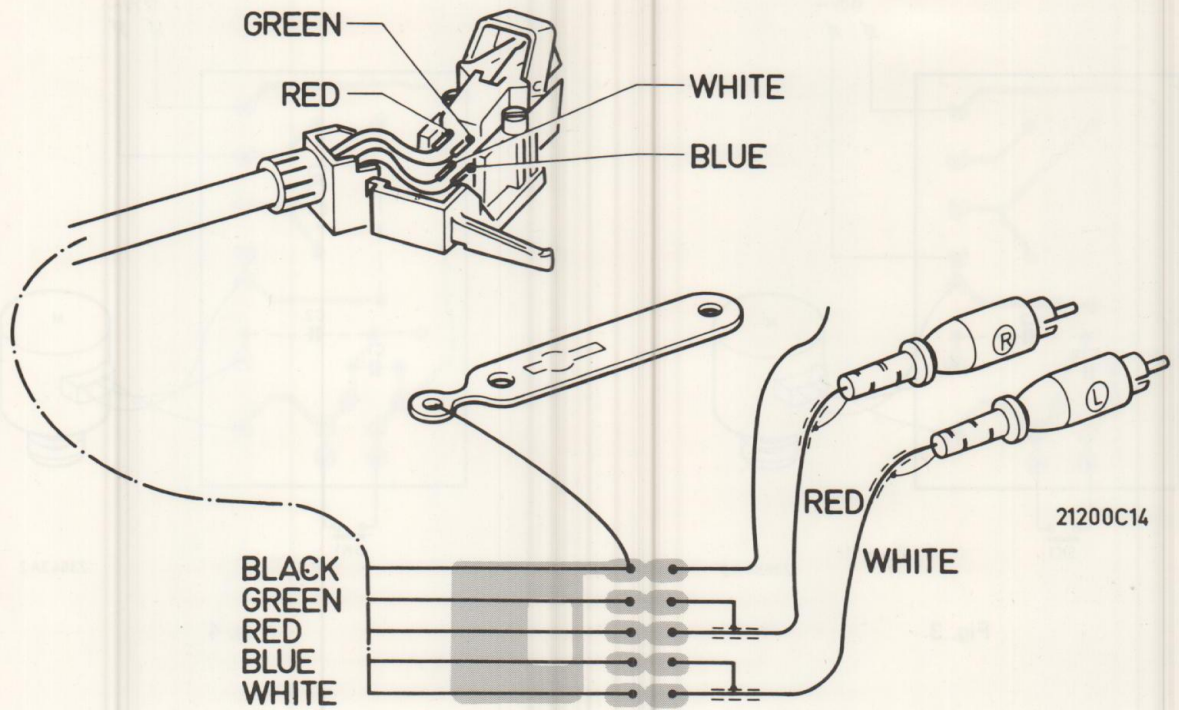

Fig. 7

GB

Safety regulations require that the set be restored to its original condition and that parts which are identical with those specified, be used.

NL

Veiligheidsbepalingen vereisen, dat het apparaat bij reparatie in zijn oorspronkelijke toestand wordt teruggebracht en dat onderdelen, identiek aan de gespecificeerde, worden toegepast.

F

Les normes de sécurité exigent que l'appareil soit remis à l'état d'origine et que soient utilisées les pièces de rechange identiques à celles spécifiées.

D

Bei jeder Reparatur sind die geltenden Sicherheitsvorschriften zu beachten. Der Originalzustand des Geräts darf nicht verändert werden; für Reparaturen sind Original-Ersatzteile zu verwenden.

I

Le norme di sicurezza esigono che l'apparecchio venga rimesso nelle condizioni originali e che siano utilizzati i pezzi di ricambio identici a quelli specificati.

S

Säkerhetsbestämmelserna kräver att varje reparation skall utföras korrekt med hänsyn till ursprunglig placering av komponenter, ledningar etc. och med användning av föreskrivna reservdelar.

DK

Myndighedernes sikkerheds- og radiostøjbestemmelser kræver, at enhver reparation skal udføres korrekt m.h.t. overholdelse af originalplacering og montering af komponenter, ledningsbundter, etc. og ved anvendelse af de foreskrevne reservedele.

N

Sikkerhetsbestemmelser kreves at apparatet blir gjenopprettet til original utførelse og at deler som er identiske med de som er spesifisert, blir benyttet.

SF

Korjattaessa laitetta on turvallisuussyistä ehdottomasti eneteltävä oikein ja käytettävä tehtaan määäämiä alkuperäisvaraosia.